

SUNSHINE®

Expert in cooking since 1978

Scan the QR code
to download
Sunshine eCatalogue

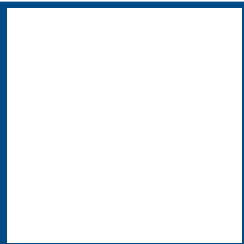

WE'RE CLOSE TO YOU

DOWNLOAD "SUNSHINE CARE" APP

- Register your Complaint in Less than 10 Seconds
- Track the State of your Complaints 24*7
- Save & Access your Product Invoice Anytime

CUSTOMER CARE NO. **0806-9529-999**

WhatsApp : **8800-366-816**

(MONDAY TO SATURDAY 10:30 AM TO 6 PM)

Corporate Office – North

A-40, Malkaganj, Main Road, Delhi-110007
Mob-11-47890060

Registered Office

Plot No. 794, Ground and First Floor Village
Shahbad Daultapur, Delhi-110042

Factory :

SUPER LPG APPLIANCES PVT. LTD. Plot No. 138,
Sec-56, Phase-v, Indl. Estate, Kundli,
Sonipat-131028 (Haryana)

Regional Office South :

Hyderabad : 4-1-4555/5,6,560, Troop Bazar, Main Rod,
Hyderabad,Telangana , 500001

West :

Gujarat : 89 Sindhi Market Opp Railway Station
Mani Nager Ahmedabad, Gujarat

East :

Kolkata : 5th Floor, Room No-507, Todi
Chambers 2, Lal Bazar Street, Kolkata,
West Bengal, 700001

Maharashtra : 603, 6th Floor, Veena Santoor
Phase 2 Mahavir Nagar, Borivall West Mumbai,
Mumbai Suburban, Maharashtra

FOLLOW US :

E-mail: support@sunshineindia.com

Get SUNSHINE Authorised Installation & Service for Best Performance
www.sunshineindia.com



PRODUCT CATALOGUE 2025

SUNSHINE®

Expert in cooking since 1978

www.sunshineindia.com

About Us

Welcome to **Sunshine Kitchen Appliances**, where innovation and quality meet to redefine your kitchen experience. **Since 1978**, Sunshine has been a pioneer in the industry, setting high benchmarks with our exquisite range of kitchen appliances.

At Sunshine, we believe in pushing boundaries. Our relentless commitment to innovation has driven us to create products that not only meet but exceed the expectations of our customers. Every Sunshine product undergoes multiple rigorous quality checks to ensure durability, performance, and safety across all product categories- cooker hoods, built-in hobs, and gas stoves.

Our products are more than just appliances; they are an essential element in every modern Indian kitchen. From sleek designs to cutting-edge technology, Sunshine products are designed to complement your lifestyle while enhancing the aesthetics of your kitchen.

Join us on this journey as we continue to innovate, inspire, and redefine the kitchen experience. Experience the Sunshine difference in your kitchen and homes today!

OUR MISSION

Since 1978, Sunshine has led the way in revolutionizing the kitchen experience for modern Indian households. Our commitment to innovation and quality is at the core of everything we do.

We strive to provide the most advanced and reliable cooker hoods, built-in hobs, and gas stoves that not only meet but exceed the expectations of our customers. Every product undergoes meticulous testing and quality checks to ensure it meets our stringent standards.

At Sunshine, we believe that a well-equipped kitchen is the heart of every home. Our products are designed to seamlessly integrate into modern Indian kitchens, offering functionality, style, and durability. Join us in our mission to elevate the cooking experience and bring joy to every kitchen we touch.

COMPANY OVERVIEW

Sunshine is a distinguished name in the kitchen appliances industry, renowned for its exceptional quality and innovative designs. Since our inception in 1978, we have continuously set new standards, making us pioneers in our field. Our commitment to excellence is reflected in every product we manufacture, including cooker hoods, built-in hobs, and gas stoves.

At Sunshine, quality is paramount. Each product undergoes a series of rigorous quality checks to ensure durability, performance, and safety. Our meticulous attention to detail guarantees that every appliance meets the highest standards, providing reliable and efficient performance for years to come.

Our products are designed to complement the modern Indian kitchen, blending seamlessly with contemporary aesthetics while offering practical solutions for everyday cooking needs. With Sunshine appliances, you can elevate your kitchen's functionality and style, creating a space that is both efficient and beautiful.

Join us in our journey to revolutionize the kitchen experience. Choose Sunshine for unparalleled quality, innovation, and style in kitchen appliances.

EXPERIENCE

 CHIMNEYS	03-18
 BUILT-IN-HOBS	19-40
 COOKTOPS	41-53



CHIMNEYS

INTELLOSENSE, BLDC, ENERGY-EFFICIENT, SILENT

TOUCH FREE CLEANING

Innovative solution that breaks away from the need of buttons to make cleaning easy and very convenient

wave sensor

Effortless control: Our kitchen chimney features wave sensor technology for a touch-free and seamless cooking experience

BLDC

BLDC Kitchen Chimney: Efficiency, silence, and durability for an upgraded cooking experience

SILENT

Experience peaceful cooking with our whisper-quiet kitchen chimneys

LIFETIME WARRANTY

Guaranteed power and convenience with a lifetime warranty on motors

LANCEL

ISLAND KITCHEN CHIMNEY

VARIANTS- 900 MM



TECHNICAL SPECIFICATIONS

Voltage (V) / Frequency (Hz)	AC220-240 / 50Hz
Motor Power (W)	150W BLDC MOTOR
Illumination Type	LED
Illumination Power	2 X max 3W
Auto Clean Type	Intelligent Heat Auto Clean
Total Power (W)	216W (150W Motor + 6W LED + 60W Element)
Suction (m3/h)	1650m3/Hr
Switch Control	Both Side Touch Control and Motion Sensor
Outlet Diameter	150 mm
Unit Dimension 90cm	L900 X W460 X H1021 (mm)

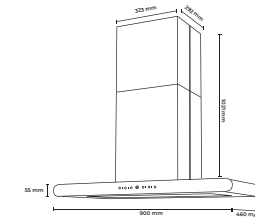

WATCH NOW

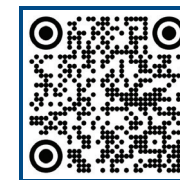

WATCH NOW

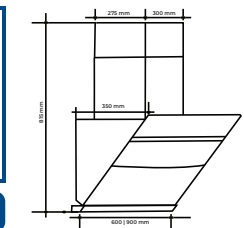

MASILO

INTELLIGENT HEAT AUTO CLEAN

VARIANTS- 600 MM, 750 MM, 900 MM



TECHNICAL SPECIFICATIONS

Voltage (V) / Frequency (Hz)	AC220-240 / 50Hz
Motor Power (W)	150W BLDC MOTOR
Illumination Type	LED
Illumination Power	2 X max 1.5W
Auto Clean Type	Intelligent Heat Auto Clean
Total Power (W)	213W (150W Motor + 3W LED + 60W Element)
Suction (m3/h)	1650m3/Hr
Switch Control	Touch Control with Motion Sensor
Outlet Diameter (mm)	150 mm
Unit Dimension 60cm	L600 X W350 X H815 (mm)
Unit Dimension 90cm	L900 X W350 X H815 (mm)

ANTON PLUS

INTELLIGENT HEAT AUTO CLEAN

VARIANTS- 600 MM 900 MM



TECHNICAL SPECIFICATIONS

Voltage (V) / Frequency (Hz)	AC220-240 / 50Hz
Motor Power (W)	150W BLDC MOTOR
Illumination Type	LED
Illumination Power	1 X max 3W
Auto Clean Type	Intelligent Heat Auto Clean
Total Power (W)	213W (150W Motor + 3W LED + 60W Element)
Suction (m3/h)	1500m3/Hr
Switch Control	Touch Control with Motion Sensor
Outlet Diameter (mm)	150 mm
Unit Dimension 60cm	L600 X W410 X H510 (mm)
Unit Dimension 90cm	L900 X W410 X H510 (mm)

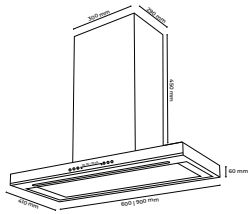

CASAVO

DESIGNER DUAL TONE CHIMNEY



VARIANTS- 600 MM 900 MM



TECHNICAL SPECIFICATIONS

Voltage (V) / Frequency (Hz)	AC220-240 / 50Hz
Motor Power (W)	150W BLDC MOTOR
Illumination Type	LED
Illumination Power	1 x 1.5W
Auto Clean Type	Intelligent Heat Auto Clean
Total Power (W)	211W (150W Motor + 1.5W LED + 60W Element)
Suction (m3/h)	1500m3/Hr
Switch Control	Touch Control with Motion Sensor
Outlet Diameter (mm)	150 mm
Unit Dimension 60cm	L600 X W425 X H515 (mm)
Unit Dimension 90cm	L900 X W425 X H515 (mm)

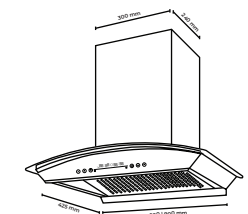

DIJON

DESIGNER DUAL TONE CHIMNEY

VARIANTS- 600 MM 900 MM



TECHNICAL SPECIFICATIONS

Voltage (V) / Frequency (Hz)	AC220-240 / 50Hz
Motor Power (W)	150W BLDC MOTOR
Illumination Type	LED
Illumination Power	1 x 1.5W
Auto Clean Type	Intelligent Heat Auto Clean
Total Power (W)	211W (150W Motor + 1.5W LED + 60W Element)
Suction (m3/h)	1500m3/Hr
Switch Control	Touch Control with Motion Sensor
Outlet Diameter (mm)	150 mm
Unit Dimension 60cm	L600 X W420 X H520 (mm)
Unit Dimension 90cm	L900 X W420 X H520 (mm)

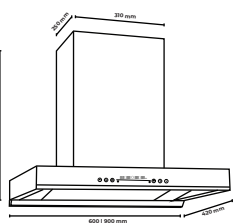

MILANO

INTELLIGENT HEAT SENSING TECHNOLOGY

VARIANTS- 600 MM 750 MM 900 MM



TECHNICAL SPECIFICATIONS

Voltage (V) / Frequency (Hz)	AC220-240 / 50Hz
Motor Power (W)	110W BLDC MOTOR
Illumination Type	LED
Illumination Power	60,75cm - 2 x 1.5W, 90cm - 1 x 2W
Auto Clean Type	Intelligent Heat Auto Clean
Total Power (W)	172W (110W Motor + 2W LED + 60W Element)
Total Power (W)	173W (110W Motor + 3W LED + 60W Element)
Suction (m3/h)	1500m3/Hr
Switch Control	Touch Control with Motion Sensor
Outlet Diameter (mm)	150 mm
Unit Dimension 60cm	L600 X W420 X H470 (mm)
Unit Dimension 75cm	L750 X W420 X H470 (mm)
Unit Dimension 90cm	L900 X W420 X H580 (mm)

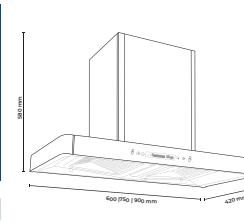
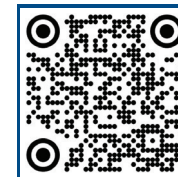

LUXOR

WITH ADVANCED BLDC MOTOR

VARIANTS- 600 MM 750 MM 900 MM



TECHNICAL SPECIFICATIONS

Voltage (V) / Frequency (Hz)	AC220-240 / 50Hz
Motor Power (W)	150W
Illumination Type	LED
Illumination Power	2 x 1.5W
Auto Clean Type	Heat Auto Clean
Total Power (W)	213W (150W Motor + 3W LED + 60W Element)
Suction (m³/h)	1350m³/hr
Switch Control	Touch Control with Motion Sensor
Outlet Diameter (mm)	150 mm
Unit Dimension 60cm	L600 X W420 X H480 (mm)
Unit Dimension 75cm	L750 X W420 X H480 (mm)
Unit Dimension 90cm	L900 X W420 X H480 (mm)

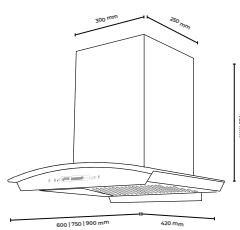

NEXON

VOICE CONTROL CHIMNEY

VARIANTS- 600 MM 750 MM 900 MM



TECHNICAL SPECIFICATIONS

Voltage (V) / Frequency (Hz)	AC220-240 / 50Hz
Motor Power (W)	180W
Illumination Type	LED
Illumination Power	2 x 1.5W
Auto Clean Type	Heat Auto Clean
Total Power (W)	233W (180W Motor + 3W LED + 50W Element)
Suction (m³/h)	1500m³/hr
Switch Control	Touch Control with Motion Sensor
Outlet Diameter (mm)	150 mm
Unit Dimension 60cm	L600 X W480 X H900 (mm)

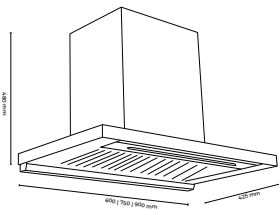
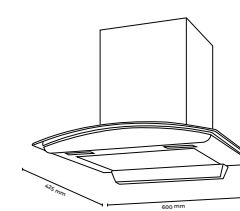

CAMELLIAS

SLIM FIT FOR SMART KITCHENS

VARIANTS- 600 MM 750 MM 900 MM



TECHNICAL SPECIFICATIONS

Voltage (V) / Frequency (Hz)	AC220-240 / 50Hz
Motor Power (W)	130W
Illumination Type	LED
Illumination Power	1 x 3W
Auto Clean Type	Heat Auto Clean
Total Power (W)	193W (130W Motor + 3W LED + 60W Element)
Suction (m³/h)	2000m³/hr
Switch Control	Touch Control with Motion Sensor
Outlet Diameter (mm)	150 mm
Unit Dimension 60cm	L600 X W425 X H480 (mm)
Unit Dimension 75cm	L750 X W425 X H480 (mm)
Unit Dimension 90cm	L900 X W425 X H580 (mm)

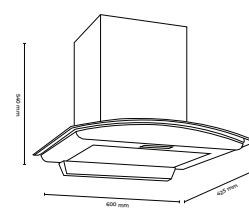
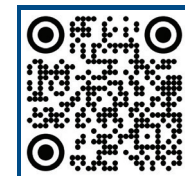

COMO

FILTERLESS TECHNOLOGY

VARIANTS- 600 MM



TECHNICAL SPECIFICATIONS

Voltage (V) / Frequency (Hz)	AC220-240 / 50Hz
Motor Power (W)	130W
Illumination Type	LED
Illumination Power	1 x 3W
Auto Clean Type	Heat Auto Clean
Total Power (W)	193W (130W Motor + 3W LED + 60W Element)
Suction (m³/h)	1350m³/hr
Switch Control	Touch Control with Motion Sensor
Outlet Diameter (mm)	150 mm
Unit Dimension 60cm	L600 X W425 X H540 (mm)

BENITO

DESIGNER DUAL TONE CHIMNEY

VARIANTS- 600 MM 750 MM 900 MM



TECHNICAL SPECIFICATIONS

Voltage (V) / Frequency (Hz)	AC220-240 / 50Hz
Motor Power (W)	180W
Illumination Type	LED
Illumination Power	1 x 1.5W
Auto Clean Type	Heat Auto Clean
Total Power (W)	241W (180W Motor + 1.5W LED + 60W Element)
Suction (m³/h)	1650m³/hr
Switch Control	Touch Control with Motion Sensor
Outlet Diameter (mm)	150 mm
Unit Dimension 60cm	L600 X W370 X H850 (mm)
Unit Dimension 75cm	L750 X W370 X H850 (mm)
Unit Dimension 90cm	L900 X W370 X H850 (mm)

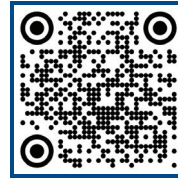
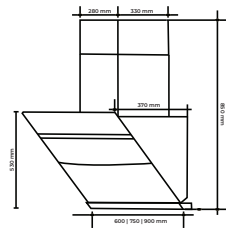

LEROY

DESIGNER DUAL TONE CHIMNEY

VARIANTS- 600 MM 900 MM



TECHNICAL SPECIFICATIONS

Voltage (V) / Frequency (Hz)	AC220-240 / 50Hz
Motor Power (W)	180W
Illumination Type	LED
Illumination Power	1 x 1.5W
Auto Clean Type	Heat Auto Clean
Total Power (W)	241W (180W Motor + 1.5W LED + 60W Element)
Suction (m³/h)	1650m³/hr
Switch Control	Touch Control with Motion Sensor
Outlet Diameter (mm)	150 mm
Unit Dimension 60cm	L600 X W420 X H520 (mm)
Unit Dimension 90cm	L900 X W420 X H520 (mm)

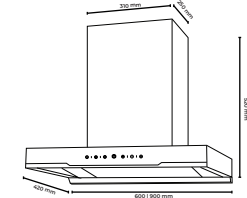

VARIANTS- 600 MM 750 MM 900 MM



TECHNICAL SPECIFICATIONS

Voltage (V) / Frequency (Hz)	AC220-240 / 50Hz
Motor Power (W)	160W
Illumination Type	LED
Illumination Power	2 x 1.5W
Auto Clean Type	Heat Auto Clean
Total Power (W)	233W (160W Motor + 3W LED + 70W Element)
Suction (m³/h)	1500m³/hr
Switch Control	Touch Control with Motion Sensor
Outlet Diameter (mm)	150 mm
Unit Dimension 60cm	L600 X W360 X H870 (mm)
Unit Dimension 60cm	L900 X W360 X H870 (mm)
Unit Dimension 90cm	L750 X W360 X H870 (mm)

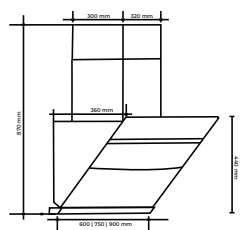

VARIANTS- 600 MM 900 MM



TECHNICAL SPECIFICATIONS

Voltage (V) / Frequency (Hz)	AC220-240 / 50Hz
Motor Power (W)	180W
Illumination Type	LED
Illumination Power	1 x 1.5W
Auto Clean Type	Heat Auto Clean
Total Power (W)	241W (180W Motor + 1.5W LED + 60W Element)
Suction (m³/h)	1650m³/hr
Switch Control	Touch Control with Motion Sensor
Outlet Diameter (mm)	150 mm
Unit Dimension 60cm	L600 X W425 X H515 (mm)
Unit Dimension 90cm	L900 X W425 X H515 (mm)

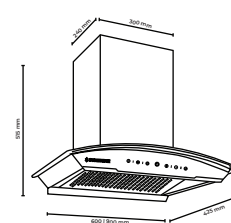
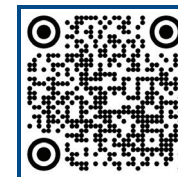

NOVEL

STYLISH MATTE-FINISHED GLASS

VARIANTS- **600** MM **750** MM **900** MM



TECHNICAL SPECIFICATIONS

Voltage (V) / Frequency (Hz)	AC220-240 / 50Hz
Motor Power (W)	130W
Illumination Type	LED
Illumination Power	1 x 3W
Auto Clean Type	Heat Auto Clean
Total Power (W)	193W (130W Motor + 3W LED + 60W Element)
Suction (m³/h)	1500m³/hr
Switch Control	Touch Control with Motion Sensor
Outlet Diameter (mm)	150 mm
Unit Dimension 60cm	L600 X W420 X H520 (mm)
Unit Dimension 90cm	L900 X W420 X H520 (mm)

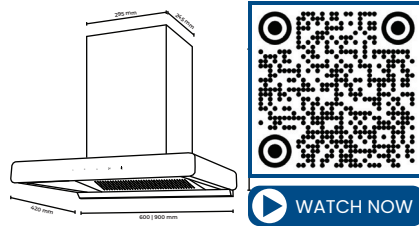

HILUX

MATTE FINISH BLACK BODY

VARIANTS- **600** MM **750** MM **900** MM



TECHNICAL SPECIFICATIONS

Voltage (V) / Frequency (Hz)	AC220-240 / 50Hz
Motor Power (W)	160W
Illumination Type	LED
Illumination Power	2 x 1.5W
Auto Clean Type	Heat Auto Clean
Total Power (W)	233W (160W Motor + 3W LED + 70W Element)
Suction (m³/h)	1500m³/hr
Switch Control	Touch Control with Motion Sensor
Outlet Diameter (mm)	150 mm
Unit Dimension 60cm	L600 X W460 X H870 (mm)
Unit Dimension 75cm	L750 X W460 X H870(mm)
Unit Dimension 90cm	L900 X W460 X H870(mm)

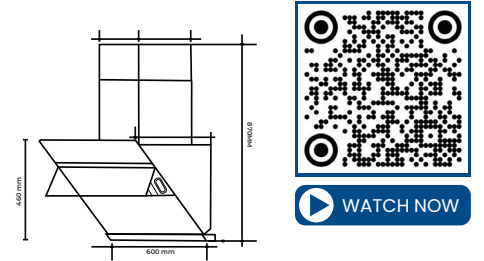

DURHAM

SLANT DESIGN CHIMNEY

VARIANTS- **600** MM **900** MM



TECHNICAL SPECIFICATIONS

Voltage (V) / Frequency (Hz)	AC220-240 / 50Hz
Motor Power (W)	130W
Illumination Type	LED
Illumination Power	1 x 3W
Auto Clean Type	Heat Auto Clean
Total Power (W)	188W (130W Motor + 3W LED + 50W Element)
Suction (m³/h)	1650m³/hr
Switch Control	Touch Control with Motion Sensor
Outlet Diameter (mm)	150 mm
Unit Dimension 60cm	L600 X W368 X H815(mm)
Unit Dimension 90cm	L900 X W368 X H815(mm)

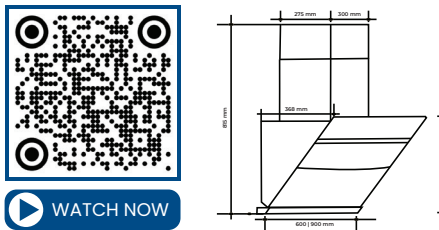

VITARA PLUS

FILTERLESS TECHNOLOGY

VARIANTS- **600** MM



TECHNICAL SPECIFICATIONS

Voltage (V) / Frequency (Hz)	AC220-240 / 50Hz
Motor Power (W)	130W
Illumination Type	LED
Illumination Power	2 x 1.5W
Auto Clean Type	Heat Auto Clean
Total Power (W)	183W (130W Motor + 3W LED + 50W Element)
Suction (m³/h)	1300m³/hr
Switch Control	Touch Control with Motion Sensor
Outlet Diameter (mm)	150 mm
Unit Dimension 60cm	L600 X W420 X H440(mm)

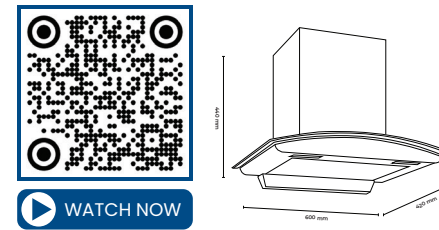

WINDSOR

DUAL HEAT SENSOR CHIMNEY

VARIANTS- 600 MM 750 MM 900 MM



TECHNICAL SPECIFICATIONS

Voltage (V) / Frequency (Hz)	AC220-240 / 50Hz
Motor Power (W)	180W
Illumination Type	LED
Illumination Power	2 x 1.5W
Auto Clean Type	Heat Auto Clean
Total Power (W)	213W (180W Motor + 3W LED + 60W Element)
Suction (m³/h)	1500m³/hr
Switch Control	Touch Control with Motion Sensor
Outlet Diameter (mm)	150 mm
Unit Dimension 60cm	L600 X W480 X H510 (mm)
Unit Dimension 75cm	L750 X W480 X H510 (mm)
Unit Dimension 90cm	L900 X W480 X H510 (mm)

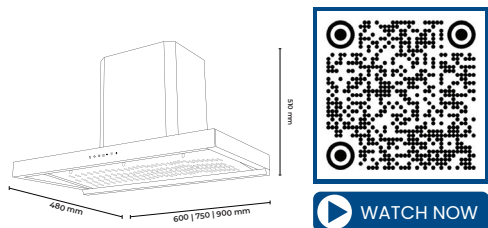

CRYSTA PLUS

FILTERLESS TECHNOLOGY

VARIANTS- 600 MM 750 MM 900 MM



TECHNICAL SPECIFICATIONS

Voltage (V) / Frequency (Hz)	AC220-240 / 50Hz
Motor Power (W)	160W
Illumination Type	LED
Illumination Power	1 x 1.5W
Auto Clean Type	Heat Auto Clean
Total Power (W)	211W (160W Motor + 1.5W LED + 50W Element)
Suction (m³/h)	1500m³/hr
Switch Control	Touch Control with Motion Sensor
Outlet Diameter (mm)	150 mm
Unit Dimension 60cm	L600 X W420 X H520 (mm)
Unit Dimension 75cm	L750 X W420 X H520 (mm)
Unit Dimension 90cm	L900 X W420 X H520 (mm)

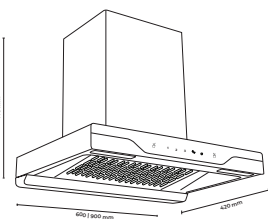
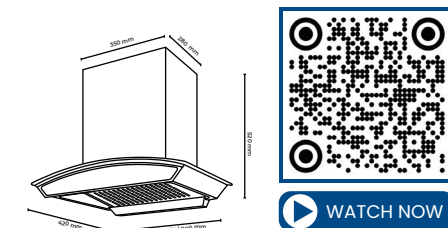

ROMA

INTELLIGENT HEAT SENSING TECHNOLOGY

VARIANTS- 600 MM 750 MM 900 MM



TECHNICAL SPECIFICATIONS

Voltage (V) / Frequency (Hz)	AC220-240 / 50Hz
Motor Power (W)	180W
Illumination Type	LED
Illumination Power	60,75cm - 2 x 1.5W, 90cm - 1 x 2W
Auto Clean Type	Intelligent Heat Auto Clean
Total Power (W) 90cm	242W (180W Motor + 2W LED + 60W Element)
Total Power (W) 60,75cm	243W (180W Motor + 3W LED + 60W Element)
Suction (m³/h)	1500m³/hr
Switch Control	Touch Control with Motion Sensor
Outlet Diameter (mm)	150 mm
Unit Dimension 60cm	L600 X W420 X H470 (mm)
Unit Dimension 75cm	L750 X W420 X H470 (mm)
Unit Dimension 90cm	L900 X W420 X H480 (mm)

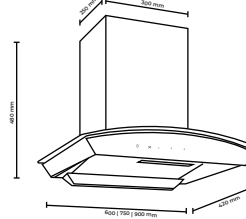

NEXA PLUS

FILTERLESS TECHNOLOGY

VARIANTS- 600 MM 750 MM 900 MM



TECHNICAL SPECIFICATIONS

Voltage (V) / Frequency (Hz)	AC220-240 / 50Hz
Motor Power (W)	180W
Illumination Type	LED
Illumination Power	1 x 3W
Auto Clean Type	Heat Auto Clean
Total Power (W)	233W (180W Motor + 3W LED + 50W Element)
Suction (m³/h)	1300m³/hr
Switch Control	Touch Control with Motion Sensor
Outlet Diameter (mm)	150 mm
Unit Dimension 60cm	L600 X W420 X H480 (mm)
Unit Dimension 75cm	L750 X W420 X H480 (mm)
Unit Dimension 90cm	L900 X W420 X H480 (mm)

AMAZE PRO DELUXE

FILTERLESS TECHNOLOGY

VARIANTS- **600** MM **750** MM **900** MM



TECHNICAL SPECIFICATIONS

Voltage (V) / Frequency (Hz)	AC220-240 / 50Hz
Motor Power (W)	200W
Illumination Type	LED
Illumination Power	2 x 1.5W
Auto Clean Type	Heat Auto Clean
Total Power (W)	263W (200W Motor + 3W LED + 60W Element)
Suction (m³/h)	1300m³/hr
Switch Control	Touch Control with Motion Sensor
Outlet Diameter (mm)	150 mm
Unit Dimension 60cm	L600 X W490 X H520 (mm)
Unit Dimension 75cm	L750 X W490 X H520(mm)
Unit Dimension 90cm	L900 X W490 X H520 (mm)

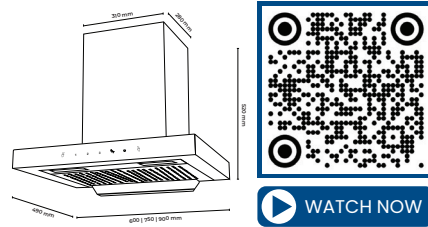

VS-2 PRO

MATTE FINISH BLACK BODY

VARIANTS- **600** MM



TECHNICAL SPECIFICATIONS

Voltage (V) / Frequency (Hz)	AC220-240 / 50Hz
Motor Power (W)	120W
Illumination Type	LED
Illumination Power	1 x 3W
Total Power (W)	123W (120W Motor + 3W LED)
Suction (m³/h)	1150m³/hr
Switch Control	Push Button Control
Outlet Diameter (mm)	150 mm
Unit Dimension 60cm	L600 X W450 X H570 (mm)

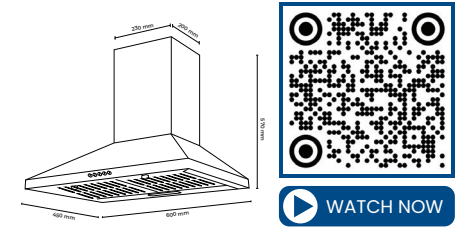

KIA

FILTERLESS TECHNOLOGY

VARIANTS- **600** MM **750** MM **900** MM



TECHNICAL SPECIFICATIONS

Voltage (V) / Frequency (Hz)	AC220-240 / 50Hz
Motor Power (W)	200W
Illumination Type	LED
Illumination Power	2 x 1.5W
Auto Clean Type	Heat Auto Clean
Total Power (W)	263W (200W Motor + 3W LED + 60W Element)
Suction (m³/h)	1300m³/hr
Switch Control	Touch Control with Motion Sensor
Outlet Diameter (mm)	150 mm
Unit Dimension 60cm	L600 X W490 X H520 (mm)
Unit Dimension 75cm	L750 X W490 X H520(mm)
Unit Dimension 90cm	L900 X W490 X H520 (mm)

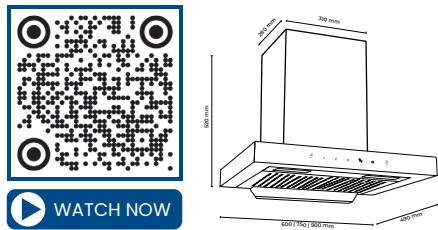

OYSTER

BAFFLE FILTER TECHNOLOGY

VARIANTS- **600** MM



TECHNICAL SPECIFICATIONS

Voltage (V) / Frequency (Hz)	AC220-240 / 50Hz
Motor Power (W)	2 x 80W
Illumination Type	LED
Illumination Power	1 x 2W
Total Power (W)	162W (160W Motor + 2W LED)
Suction (m³/h)	1040m³/hr
Switch Control	Push Button Control
Outlet Diameter (mm)	150 mm
Unit Dimension 60cm	L595 X W495 X H135 (mm)

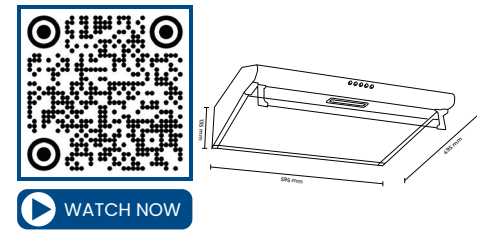

CIENA

FILTERLESS AUTO CLEAN CHIMNEY

VARIANTS: 600 MM 900 MM



TECHNICAL SPECIFICATIONS

Voltage (V) / Frequency (Hz)	AC220-240 / 50Hz
Motor Power (W)	140W
Illumination Type	LED
Illumination Power	1 x 1.5W
Auto Clean Type	Heat Auto Clean
Total Power (W)	191.5W (140W Motor + 1.5W LED + 50W Element)
Suction (m³/h)	1400m³/hr
Switch Control	Touch Control with Motion Sensor
Blower Type	Metallic Blower
Outlet Diameter (mm)	150 mm
Unit Dimension 90cm	L900 X W420 X H445 (mm)
Unit Dimension 60cm	L600 X W420 X H445 (mm)

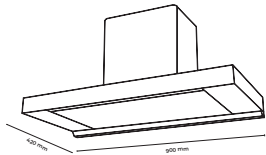

WATCH NOW



ELIXIR

FILTERLESS AUTO CLEAN CHIMNEY

VARIANTS: 600 MM



TECHNICAL SPECIFICATIONS

Voltage (V) / Frequency (Hz)	AC220-240 / 50Hz
Motor Power (W)	150W
Illumination Type	LED
Illumination Power	1 x 2W
Auto Clean Type	Heat Auto Clean
Total Power (W)	213W (150W Motor + 3W LED + 60W Element)
Suction (m³/h)	1350m³/hr
Switch Control	Touch Control with Motion Sensor
Outlet Diameter (mm)	150 mm
Unit Dimension 60cm	L600 X W420 X H480 (mm)



WATCH NOW

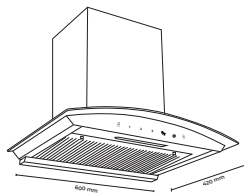

LORENZO

MULTIMEDIA DISPLAY CHIMNEY

VARIANTS: 600 MM 750 MM 900 MM



TECHNICAL SPECIFICATIONS

Voltage (V) / Frequency (Hz)	AC220-240 / 50Hz
Motor Power (W)	150W
Illumination Type	LED
Illumination Power	2 x 1.5W
Auto Clean Type	Heat Auto Clean
Total Power (W)	213W (150W Motor + 3W LED + 60W Element)
Suction (m³/h)	1500m³/hr
Switch Control	Touch Control with Motion Sensor
Outlet Diameter (mm)	150 mm
Unit Dimension 60cm	L600 X W425 X H515 (mm)
Unit Dimension 75cm	L750 X W485 X H515 (mm)
Unit Dimension 90cm	L900 X W485 X H515 (mm)



WATCH NOW

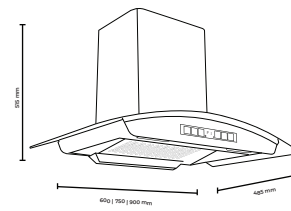

ACCORD SERIES



WATCH NOW



AESTHETIC DESIGNS

Sleek designs, vibrant colors and innovative solutions bring power and elegance to suit evolving customer tastes.



FLAME FAILURE SAFETY DEVICE

A flame failure safety device is a feature in gas appliances that shuts off the gas supply if the flame unexpectedly goes out. It prevents the release of unburned gas, enhancing safety and reducing the risk of accidents.



PREMIUM IGNITION PIN BRASS COVER

The auto electric ignition gives the customer complete freedom from lighters and other external ignition tools. The Sunshine Hob's ignition Pin comes with a protective brass cover that increases the service life of the pin.



FULL BRASS BURNERS

Full brass burners offer durability, even heat distribution, and resistance to high temperatures, making them long-lasting and efficient for gas appliances.

★ WARRANTY ★

- 10 Years on Glass
- 5 Years on Burners & Valves
- 2 Years Comprehensive



FLAME FAILURE SAFETY DEVICE

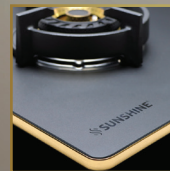

MATTE FINISH TOUGHENED GLASS WITH EDGE GUARD



POWERFUL FLAME OUTPUT



FLAME GUARD PAN SUPPORT



ACCORD 904

MATTE FINISH TOUGHENED GLASS WITH EDGE GUARD

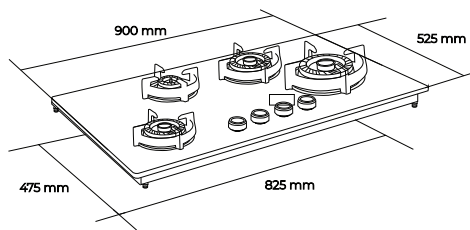

TECHNICAL SPECIFICATIONS

Indian Full Brass Burners
 Black Toughened Matte Glass
 Premium Metal Knobs with Golden Finish
 Burners - 1 X 4.5 kW , 2 X 3.5 kW , 1 X 1.7 kW
 Flame Guard Pan Support
 Flame Failure Safety Device
 Battery Operated Auto Ignition
 Hob dimensions (L x W) - 900 x 525 mm
 Cut out dimensions (L x W) - 825 x 475 mm



ACCORD 783

MATTE FINISH TOUGHENED GLASS WITH EDGE GUARD

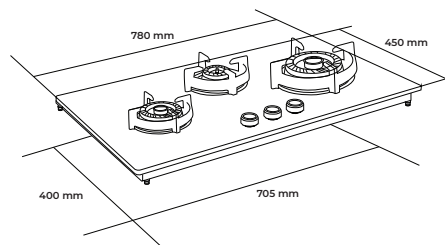

TECHNICAL SPECIFICATIONS

Indian Full Brass Burners
 Black Toughened Matte Glass
 Premium Metal Knobs with Golden Finish
 Burners - 1 X 4.5 kW , 1 X 3.5 kW , 1 X 1.7 kW
 Flame Guard Pan Support
 Flame Failure Safety Device
 Battery Operated Auto Ignition
 Hob dimensions (L x W) - 780 x 450 mm
 Cut out dimensions (L x W) - 705 x 400 mm



ACCORD 804

MATTE FINISH TOUGHENED GLASS WITH EDGE GUARD

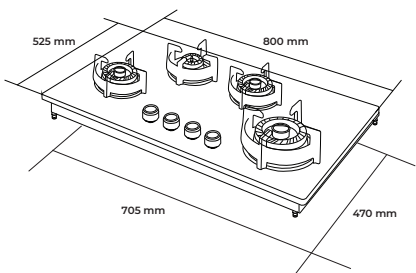

TECHNICAL SPECIFICATIONS

Indian Full Brass Burners
 Black Toughened Matte Glass
 Premium Metal Knobs with Golden Finish
 Burners - 1 X 4.5 kW , 2 X 3.5 kW , 1 X 1.7 kW
 Flame Guard Pan Support
 Flame Failure Safety Device
 Battery Operated Auto Ignition
 Hob dimensions (L x W) - 800 x 525 mm
 Cut out dimensions (L x W) - 705 x 470 mm



ACCORD 604

MATTE FINISH TOUGHENED GLASS WITH EDGE GUARD



TECHNICAL SPECIFICATIONS

Indian Full Brass Burners
Black Toughened Matte Glass
Premium Metal Knobs with Golden Finish
Burners - 1 X 4.5 kW , 1 X 3.5 kW , 2 X 1.7 kW
Flame Guard Pan Support
Flame Failure Safety Device
Battery Operated Auto Ignition
Hob dimensions (L x W) - 595 x 525 mm
Cut out dimensions (L x W) - 555 x 475 mm

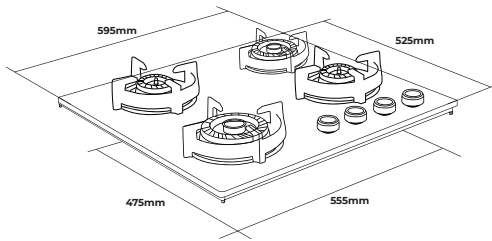

ACCORD 603

MATTE FINISH TOUGHENED GLASS WITH EDGE GUARD

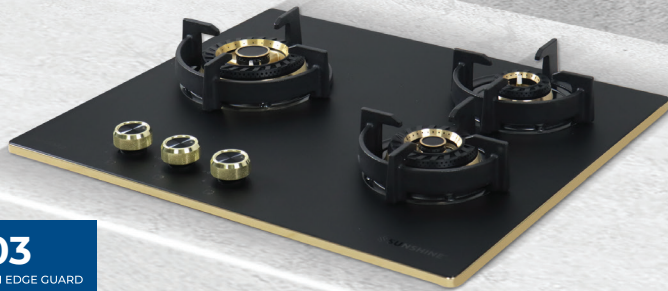

TECHNICAL SPECIFICATIONS

Indian Full Brass Burners
Black Toughened Matte Glass
Premium Metal Knobs with Golden Finish
Burners - 1 X 4.5 kW , 1 X 3.5 kW , 1 X 1.7 kW
Flame Guard Pan Support
Flame Failure Safety Device
Battery Operated Auto Ignition
Hob dimensions (L x W) - 595 x 525 mm
Cut out dimensions (L x W) - 555 x 475 mm

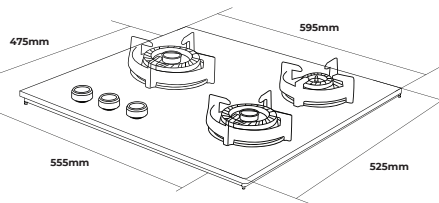

A Game Changer for
Your Daily Meals



FIDELIO TIMER SERIES



WATCH NOW



★ WARRANTY ★
 5 Years on Glass
 5 Years on Burners & Valves
 2 Years Comprehensive



IN BUILT DIGITAL TIMER



FLAME FAILURE SAFETY DEVICE

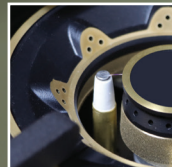

PREMIUM IGNITION PIN



POWERFUL FLAME OUTPUT



FIDELIO TIMER 904
 IN BUILT DIGITAL TIMER

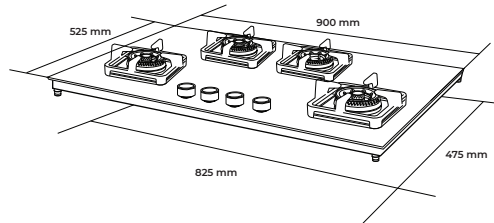

TECHNICAL SPECIFICATIONS

- Indian Full Brass Burners
- Black Toughened Glass
- Premium Metal Knobs
- Burners - 1X4.5kW ,2X3.5kW ,1X1.7kW
- Cast Iron Pan Support
- In Built Digital Timer
- Flame Failure Safety Device
- Battery Operated Auto Ignition
- Hob Dimensions (LXW) - 900 x 525mm
- Cut Out Dimensions (LXW) - 825 x 475mm



FIDELIO TIMER 804
 IN BUILT DIGITAL TIMER

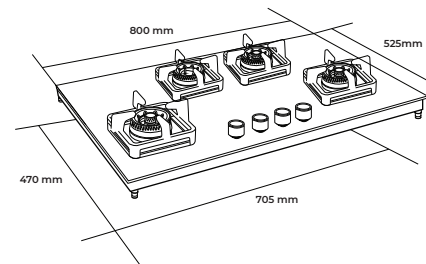

TECHNICAL SPECIFICATIONS

- Indian Full Brass Burners
- Black Toughened Glass
- Premium Metal Knobs
- Burners - 1X4.5kW ,2X3.5kW ,1X1.7kW
- Cast Iron Pan Support
- In Built Digital Timer
- Flame Failure Safety Device
- Battery Operated Auto Ignition
- Hob Dimensions (LXW) - 800 x 525mm
- Cut Out Dimensions (LXW) - 705 x 470mm

FIDELIO SERIES



▶ WATCH NOW



★ **WARRANTY** ★
 5 Years on Glass
 5 Years on Burners & Valves
 2 Years Comprehensive

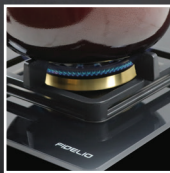

CAST IRON PAN SUPPORT



PREMIUM METAL KNOBS

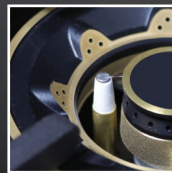

PREMIUM IGNITION PIN



POWERFUL FLAME OUTPUT



FIDELIO 904

PREMIUM METAL KNOB

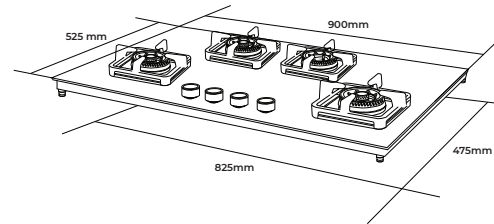

TECHNICAL SPECIFICATIONS

- Indian Full Brass Burners
- Black Toughened Glass
- Premium Metal Knobs
- Burners - 1 X 4.5kW, 2 X 3.5kW, 1 X 1.7kW
- Cast Iron Pan Support
- Battery Operated Auto Ignition
- Hob Dimensions (LxW) 900 x 525mm
- Cut Out Dimensions (LxW) 825 x 475mm



FIDELIO 804

PREMIUM METAL KNOB

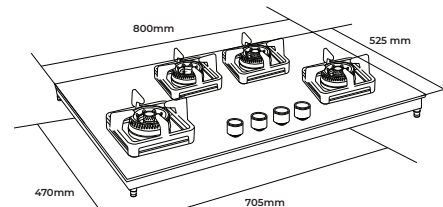

TECHNICAL SPECIFICATIONS

- Indian Brass Burners
- Black Toughened Glass
- Premium Metal Knobs
- Burners - 1 X 4.5kW, 2 X 3.5kW, 1 X 1.7kW
- Cast Iron Pan Support
- Battery Operated Auto Ignition
- Hob Dimensions (LxW) 800 x 525mm
- Cut Out Dimensions (LxW) 705 x 470mm



FIDELIO 783
PREMIUM METAL KNOB

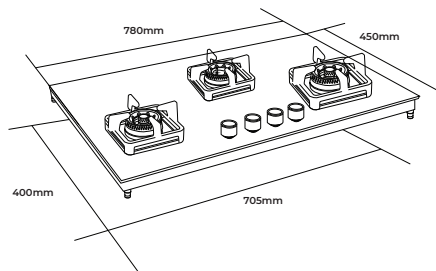

TECHNICAL SPECIFICATIONS

- Indian Brass Burners
- Black Toughened Glass
- Premium Metal Knobs
- Burners - 1 X 4.5kW, 1 X 3.5kW, 1 X 1.7kW
- Cast Iron Pan Support
- Battery Operated Auto Ignition
- Hob Dimensions (LxW) 780 x 450mm
- Cut Out Dimensions (LxW) 705 x 400mm

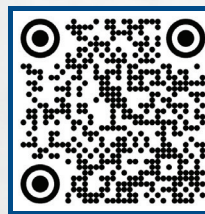

HARMONY SERIES



★ **WARRANTY** ★

- 5 Years on Glass
- 5 Years on Burners & Valves
- 2 Years Comprehensive



CAST IRON PAN SUPPORT

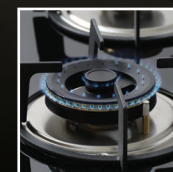

POWERFUL FLAME OUTPUT

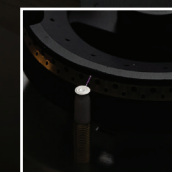

PREMIUM IGNITION PIN

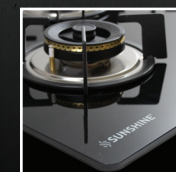

TOUGHENED GLASS



HARMONY 904
POWERFUL FLAME OUTPUT

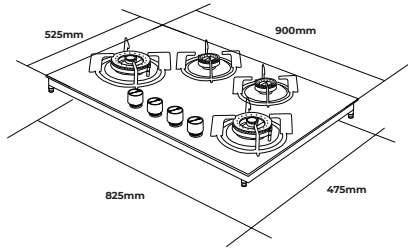

TECHNICAL SPECIFICATIONS

- Indian Brass Burners
- Black Toughened Glass
- Premium Metal Knobs
- Burners - 2 X 3.5kW, 2 X 1.7kW
- Cast Iron Pan Support
- Battery Operated Auto Ignition
- Hob Dimensions (LXW) 900 x 525mm
- Cut Out Dimensions (LXW) 825 x 475mm



HARMONY 654
POWERFUL FLAME OUTPUT

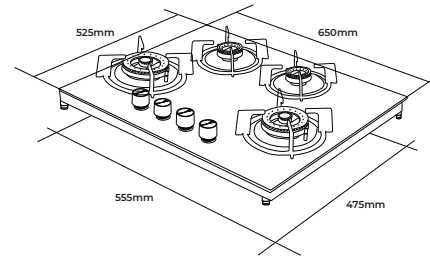

TECHNICAL SPECIFICATIONS

- Indian Brass Burners
- Black Toughened Glass
- Premium Metal Knobs
- Burners - 2 X 3.5kW, 2 X 1.7kW
- Cast Iron Pan Support
- Battery Operated Auto Ignition
- Hob Dimensions (LXW) 650 x 525mm
- Cut Out Dimensions (LXW) 555 x 475mm



HARMONY 783
POWERFUL FLAME OUTPUT

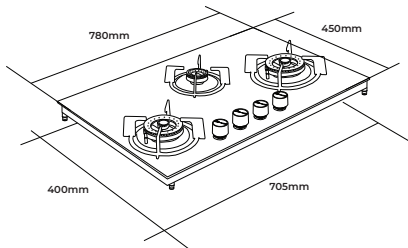

TECHNICAL SPECIFICATIONS

- Indian Brass Burners
- Black Toughened Glass
- Premium Metal Knobs
- Burners - 2 X 3.5kW, 1 X 1.7kW
- Cast Iron Pan Support
- Battery Operated Auto Ignition
- Hob Dimensions (LXW) 780 x 450mm
- Cut Out Dimensions (LXW) 705 x 400mm



ALESSIO SERIES



WATCH NOW



★ **WARRANTY** ★

10 Years on Glass
5 Years on Burners & Valves
2 Years Comprehensive



BLACK TOUGHENED
MATTE GLASS

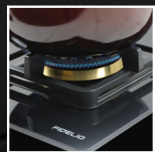

CAST IRON PAN SUPPORT



PREMIUM METAL KNOBS

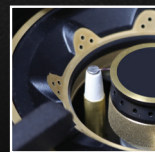

PREMIUM IGNITION PIN



POWERFUL FLAME OUTPUT



ALESSIO 904

PREMIUM METAL KNOB

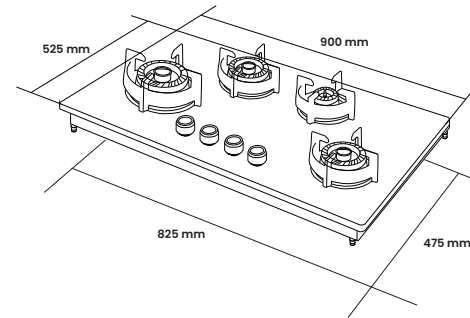

TECHNICAL SPECIFICATIONS

Indian Full Brass Burners
Black Toughened Matte Glass
Premium Metal Knobs
Burners - 1 X 4.5kW, 2 X 3.5kW, 1 X 1.7kW
Flame Guard Pan Support
Battery Operated Auto Ignition
Hob Dimensions (LxW) 900 x 525mm
Cut Out Dimensions (LxW) 825 x 475 mm

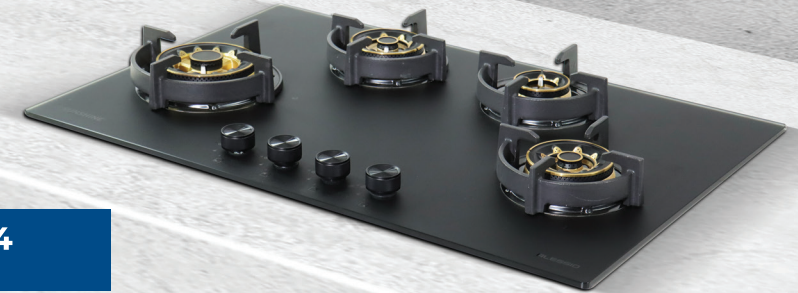

ALESSIO 804

PREMIUM METAL KNOB

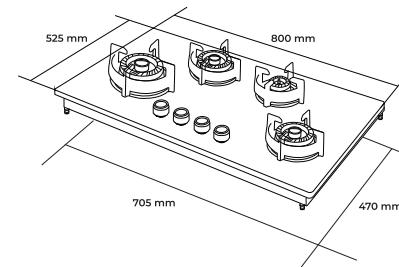

TECHNICAL SPECIFICATIONS

Indian Full Brass Burners
Black Toughened Matte Glass
Premium Metal Knobs
Burners - 1 X 4.5kW, 2 X 3.5kW, 1 X 1.7kW
Flame Guard Pan Support
Battery Operated Auto Ignition
Hob Dimensions (LxW) 800 x 525mm
Cut Out Dimensions (LxW) 705 x 470 mm



ALESSIO 604
PREMIUM METAL KNOB

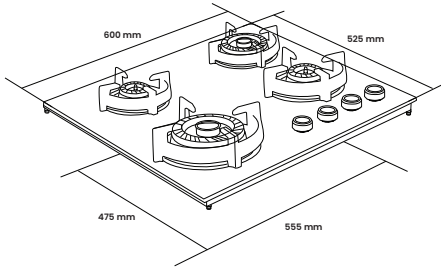

TECHNICAL SPECIFICATIONS

- Indian Full Brass Burners
- Black Toughened Matte Glass
- Premium Metal Knobs
- Burners - 1 X 4.5kW ,1 X 3.5kW ,2 X 1.7kW
- Flame Guard Pan Support
- Battery Operated Auto Ignition
- Hob dimensions (L x W) - 600 x 450 mm
- Cut out dimensions (L x W) - 555 x 475 mm



ALESSIO 783
PREMIUM METAL KNOB

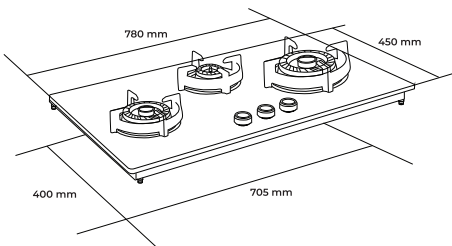

TECHNICAL SPECIFICATIONS

- Indian Full Brass Burners
- Black Toughened Matte Glass
- Premium Metal Knobs
- Burners - 1 X 4.5kW ,1 X 3.5kW ,1 X 1.7kW
- Flame Guard Pan Support
- Battery Operated Auto Ignition
- Hob dimensions (L x W) - 780 x 450 mm
- Cut out dimensions (L x W) - 705 x 400 mm

VELLFIRE SERIES

WATCH NOW



★ WARRANTY ★
10 Years on Glass
5 Years on Burners & Valves
2 Years Comprehensive



CAST IRON PAN SUPPORT



BLACK TOUGHENED MATTE GLASS



PREMIUM METAL KNOBS



PREMIUM IGNITION PIN



POWERFUL FLAME OUTPUT



VELLFIRE 904
BLACK TOUGHENED MATTE GLASS



VELLFIRE 783
BLACK TOUGHENED MATTE GLASS

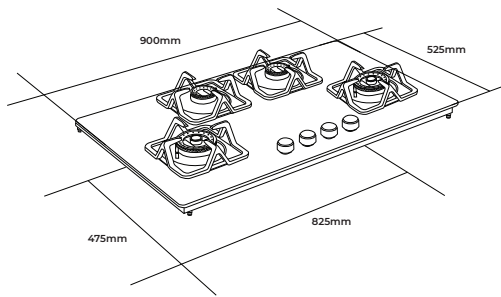

TECHNICAL SPECIFICATIONS

- Indian Brass Burners
- Black Toughened Glass
- Premium Metal Knobs
- Burners - 2 X 3.5kW, 2 X 1.7kW
- Cast Iron Pan Support
- Battery Operated Auto Ignition
- Hob Dimensions (LXW) 900 x 525mm
- Cut Out Dimensions (LXW) 825 x 475mm

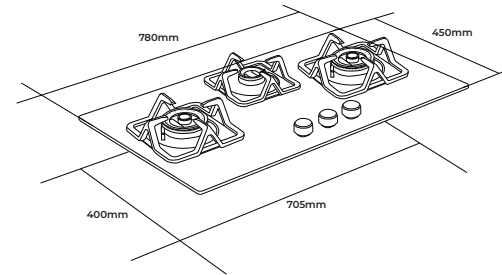

TECHNICAL SPECIFICATIONS

- Indian Brass Burners
- Black Toughened Glass
- Premium Metal Knobs
- Burners - 2 X 3.5kW, 1 X 1.7kW
- Cast Iron Pan Support
- Battery Operated Auto Ignition
- Hob Dimensions (LXW) 780 x 450mm
- Cut Out Dimensions (LXW) 705 x 400mm



VELLFIRE 654
BLACK TOUGHENED MATTE GLASS

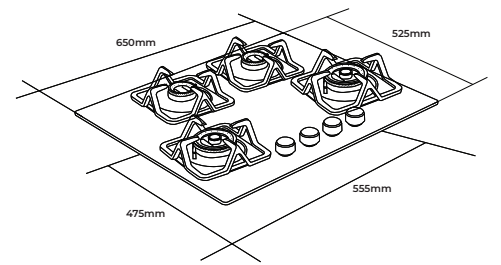

TECHNICAL SPECIFICATIONS

- Indian Brass Burners
- Black Toughened Glass
- Premium Metal Knobs
- Burners - 2 X 3.5kW, 2 X 1.7kW
- Cast Iron Pan Support
- Battery Operated Auto Ignition
- Hob Dimensions (LXW) 650 x 525mm
- Cut Out Dimensions (LXW) 555 x 475mm



CARNIVAL PLUS SERIES



WATCH NOW



★ **WARRANTY** ★

8 Years on Glass
5 Years on Burners & Valves
2 Years Comprehensive

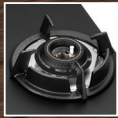

FLAME GUARD PAN SUPPORT

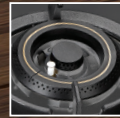

3RD GENERATION BRASS BURNER



DUAL TONE METAL KNOB



MATTE FINISH TOUGHENED GLASS



CARNIVAL PLUS 4B
3RD GENERATION BRASS BURNER

TECHNICAL SPECIFICATIONS

Indian Brass Burners
Matte Toughened Glass
Dual Tone Metal Knobs
Burners - 1 X 3.5kW, 1 X 2.5kW, 2 X 1.7kW
Flame Guard Pan Support
Battery Operated Auto Ignition
Hob Dimensions (LxW) 760 x 450mm

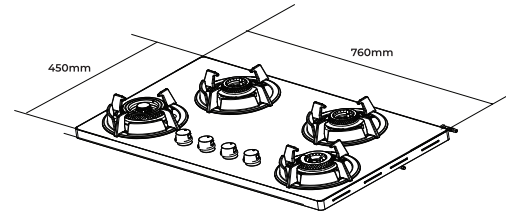

CARNIVAL PLUS 3B
3RD GENERATION BRASS BURNER

TECHNICAL SPECIFICATIONS

Indian Brass Burners
Matte Toughened Glass
Dual Tone Metal Knobs
Burners - 1 X 3.5kW, 1 X 2.5kW, 1 X 1.7kW
Flame Guard Pan Support
Battery Operated Auto Ignition
Hob Dimensions (LxW) 760 x 450mm

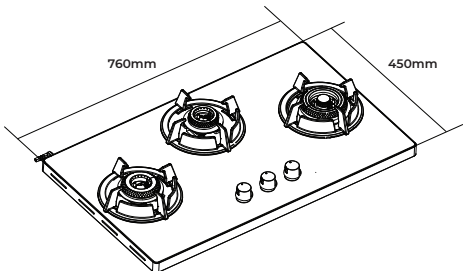

CARNIVAL PLUS 654
3RD GENERATION BRASS BURNER

TECHNICAL SPECIFICATIONS

Indian Brass Burners
Matte Toughened Glass
Dual Tone Metal Knobs
Burners - 1 X 3.5kW, 1 X 2.5kW, 2 X 1.7kW
Flame Guard Pan Support
Battery Operated Auto Ignition
Hob Dimensions (LxW) 654 x 520mm

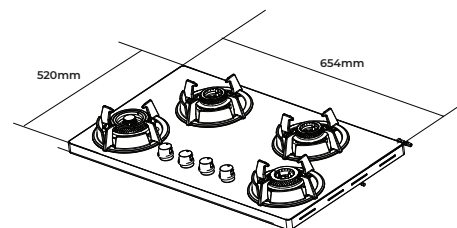



COOKTOPS THAT KEEP CONVENIENCE ON THE TOP



JUMBO BURNER

Jumbo burner improve cooking time efficiency



HASSLE FREE

Auto-ignition with soft touch button to enjoy hassle free cooking



HEAVY DUTY

Single joint frame for stronger and long lasting body



SECURITY

5 year warranty on glass and valve

SHINE

WITH FLAME GUARD PAN SUPPORT

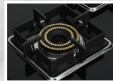

FLAME GUARD PAN SUPPORT



ERGONOMIC METAL KNOB



TEMPERED GLASS



PRECI FLAME BRASS BURNER



WATCH NOW



SHINE 3B

Dimension (mm): 750 x 510 (L x W)



SHINE 4B

Dimension (mm): 750 x 520 (L x W)



SHINE 5B

Dimension (mm): 900 x 550 (L x W)

WARRANTY 5 Years on Burner & Valve, 3 Years on Glass, 3 Years Comprehensive

Auto Ignition Variants are also Available



WATCH NOW

SHINE GOLD

WITH FLAME GUARD PAN SUPPORT



FLAME GUARD PAN SUPPORT



PREMIUM METAL KNOBS



MATTE FINISH TOUGHENED GLASS WITH EDGE GUARD

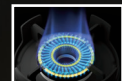

PRECI FLAME BRASS BURNER



SHINE GOLD 3B

Dimension (mm): 750 x 510 (L x W)



SHINE GOLD 4B

Dimension (mm): 750 x 525 (L x W)

WARRANTY 5 Years on Burner & Valve, 3 Years on Glass, 3 Years Comprehensive



WATCH NOW



ROYAL BLUE WITH 3D BURNER



CAST IRON PAN SUPPORT

3D BURNER

SLIM BODY

DESIGNER BAKELITE KNOB

REGAL PRO WITH ULTRA SLIM FRAME



WATCH NOW



CAST IRON PAN SUPPORT

HIGH FUEL EFFICIENT BURNER

ULTRA SLIM FRAME

ERGONOMIC KNOB



ROYAL BLUE 2B

Dimension (mm): 700 x 360 (L x W)

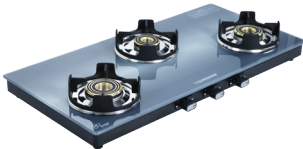

ROYAL BLUE 3B

Dimension (mm): 770 x 380 (L x W)

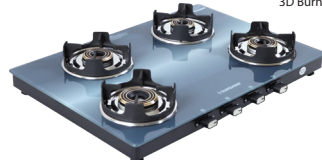

ROYAL BLUE 4B

Dimension (mm): 690 x 480 (L x W)



REGAL PRO 2B

Dimension (mm): 700 x 360 (L x W)



REGAL PRO 3B

Dimension (mm): 770 x 380 (L x W)



REGAL PRO 4B

Dimension (mm): 635 x 500 (L x W)



REGAL PRO MAX 4B

Dimension (mm): 690 x 480 (L x W)



WARRANTY * 1 Years on Burner & Valve, 2 Years on Glass, 3 Years Comprehensive

WARRANTY * 1 Years on Burner & Valve, 2 Years on Glass, 3 Years Comprehensive

Auto Ignition Variants are also Available



WATCH NOW



NOVA WITH HIGH FUEL EFFICIENT BURNER



CAST IRON PAN SUPPORT

HIGH FUEL EFFICIENT BURNER

DUAL TONE TOUGHENED GLASS

DUAL TONE KNOB DESIGN



WATCH NOW



ARROW WITH CAST IRON PAN SUPPORT



CAST IRON PAN SUPPORT

PRECI FLAME BRASS BURNER

DUAL TONE TOUGHENED GLASS

DUAL TONE KNOB DESIGN



NOVA 3B

Dimension (mm): 770 x 380 (L x W)



NOVA 4B

Dimension (mm): 690 x 480 (L x W)



WARRANTY * 1 Years on Burner & Valve, 2 Years on Glass, 3 Years Comprehensive

Auto Ignition Variants are also Available



4D Burner



ARROW 2B

Dimension (mm): 700 x 360 (L x W)



ARROW 3B

Dimension (mm): 770 x 380 (L x W)

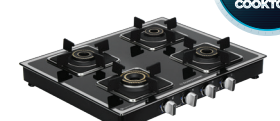

ARROW 4B

Dimension (mm): 690 x 480 (L x W)



WARRANTY * 1 Years on Burner & Valve, 2 Years on Glass, 3 Years Comprehensive

Auto Ignition Variants are also Available

VENUE PLUS

WITH FLAME GUARD PAN SUPPORT

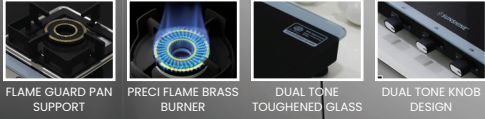

FLAME GUARD PAN SUPPORT

PRECI FLAME BRASS BURNER

DUAL TONE TOUGHENED GLASS

DUAL TONE KNOB DESIGN



VENUE PLUS 3B

Dimension (mm): 770 x 380 (L x W)



VENUE PLUS 4B

Dimension (mm): 690 x 480 (L x W)



4D Burner

WARRANTY 3 Years on Burner & Valve, 5 Years on Glass, 2 Years Comprehensive

Auto Ignition Variants are also Available



WATCH NOW

SAPPHIRE

WITH FLAME GUARD PAN SUPPORT



CAST IRON PAN SUPPORT

3D BURNER

TOUGHENED GLASS

DESIGNER BAKELITE KNOB



3D Burner

SAPPHIRE 2B

Dimension (mm): 700 x 360 (L x W)



SAPPHIRE 3B

Dimension (mm): 770 x 380 (L x W)



SAPPHIRE 4B

Dimension (mm): 690 x 480 (L x W)

WARRANTY 3 Years on Burner & Valve, 5 Years on Glass, 2 Years Comprehensive

Auto Ignition Variants are also Available



WATCH NOW



PRECI FLAME BRASS BURNER



TOUGHENED GLASS WITH EDGE GUARD



METALLIC KNOB

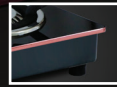

SLIP PROOF LEG



4D Burner



DONNA ROSE GOLD DX 3B

Dimension (mm): 770 x 380 (L x W)



DONNA ROSE GOLD DX 4B

Dimension (mm): 690 x 480 (L x W)

WARRANTY 3 Years on Burner & Valve, 5 Years on Glass, 2 Years Comprehensive

Auto Ignition Variants are also Available



WATCH NOW

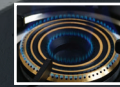

3D BURNER



CAST IRON PAN SUPPORT



BLACK METALLIC KNOB

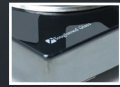

TOUGHENED GLASS WITH METALLIC FRAME



3D Burner

VERNA 3B

Dimension (mm): 770 x 380 (L x W)



VERNA 4B

Dimension (mm): 690 x 480 (L x W)

WARRANTY 3 Years on Burner & Valve, 5 Years on Glass, 2 Years Comprehensive

Auto Ignition Variants are also Available





WATCH NOW

TITAN WITH CAST IRON PAN SUPPORT



MS COATED PAN SUPPORT

PRECI FLAME BURNER

SLIP PROOF LEG

STYLISH & BAKELITE KNOB



WATCH NOW

OLYMPIC WITH FORGED BRASS BURNER



FORGED BRASS BURNER

CAST IRON PAN SUPPORT

TOUGHENED GLASS

DUAL TONE KNOB DESIGN



6D Burner



TITAN 3B
Dimension (mm):: 720 x 380 (L x W)



TITAN 4B
Dimension (mm):: 585 x 500 (L x W)

WARRANTY 5 Years on Burners & Valves, 3 Years on Glass, 2 Years Comprehensive

Auto Ignition Variants are also Available



OLYMPIC GOLD 4B
Dimension (mm):: 950 x 370 (L x W)



OLYMPIC SILVER 4B
Dimension (mm):: 950 x 370 (L x W)

WARRANTY 5 Years on Burners & Valves, 3 Years on Glass, 2 Years Comprehensive

Auto Ignition Variants are also Available



WATCH NOW

MAGIC PLUS WITH PRECI FLAME BRASS BURNER



PRECI FLAME BRASS BURNER

MS COATED PAN SUPPORT

TOUGHENED GLASS

DUAL TONE KNOB DESIGN



WATCH NOW

THAR WITH MATTE FINISH TOUGHENED GASS



PRECI FLAME BURNER

BLACK METALLIC KNOB

MATTE FINISH TOUGHENED GLASS

FLAME GUARD PAN SUPPORT



4D Burner



MAGIC PLUS 2B
Dimension (mm):: 700 x 360 (L x W)



MAGIC PLUS 3B
Dimension (mm):: 770 x 380 (L x W)



MAGIC PLUS 4B
Dimension (mm):: 690 x 480 (L x W)

WARRANTY 5 Years on Burners & Valves, 3 Years on Glass, 2 Years Comprehensive

Auto Ignition Variants are also Available

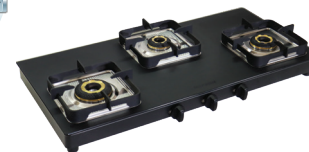

Thar 3B
Dimension (mm):: 720 x 380 (L x W)



Thar 4B
Dimension (mm):: 585 x 500 (L x W)

WARRANTY 5 Years on Burners & Valves, 3 Years on Glass, 2 Years Comprehensive

Auto Ignition Variants are also Available



7D BURNER



WATCH NOW



TURBO WITH PRECI FLAME BURNER

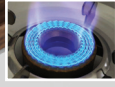

PRECI FLAME BURNER

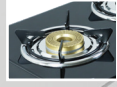

MS COATED PAN SUPPORT



TOUGHENED GLASS



STYLISH & BAKELITE KNOB

ENZO WITH HIGH GLOSS STAINLESS STEEL



HEXA PAN SUPPORT

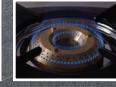

HIGH EFFICIENCY BRASS BURNER

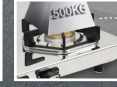

HIGH GLOSS STAINLESS STEEL

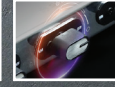

STYLISH & BAKELITE KNOB



WATCH NOW

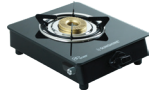

TURBO 1B
Dimension (mm): 300 x 350 (L x W)



TURBO 2B
Dimension (mm): 590 x 290 (L x W)



TURBO 3B
Dimension (mm): 690 x 340 (L x W)



TURBO 4B
Dimension (mm): 585 x 500 (L x W)

★ WARRANTY ★
5 Years on Burners & Valves
3 Years on Glass
3 Years Comprehensive



ENZO 3B
Dimension (mm): 770 x 380 (L x W)



ENZO 4B
Dimension (mm): 730 x 500 (L x W)

★ WARRANTY ★
5 Years on Burners & Valves
3 Years Comprehensive

Auto Ignition Variants are also Available



WATCH NOW



SUPER WITH PRECI FLAME BURNER

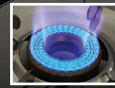

PRECI FLAME BURNER

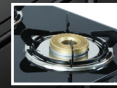

DOUBLE DRIP TRAY AND MS COATED PAN SUPPORT



TOUGHENED GLASS



STYLISH & BAKELITE KNOB



WATCH NOW



SHIELD PLUS WITH HEAVY STAINLESS STEEL BODY



HIGH EFFICIENCY BRASS BURNER



CAST IRON PAN SUPPORT



HEAVY STAINLESS STEEL BODY



DESIGNER KNOB



SUPER 2B
Dimension (mm): 700 x 360 (L x W)



SUPER 3B
Dimension (mm): 770 x 380 (L x W)



SUPER 4B
Dimension (mm): 635 x 500 (L x W)

★ WARRANTY ★
5 Years on Burners & Valves
3 Years on Glass
3 Years Comprehensive



SHIELD PLUS 3B
Dimension (mm): 770 x 380 (L x W)



SHIELD PLUS 4B
Dimension (mm): 730 x 500 (L x W)

★ WARRANTY ★
5 Years on Burners & Valves
3 Years Comprehensive

Auto Ignition Variants are also Available

BRIO
WITH ULTRA SLIM BODY

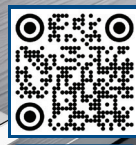

WATCH NOW



MAJESTIC
WITH ULTRA SLIM BODY



WATCH NOW



BRIO 2B Dimension (mm): 640 x 320 (L x W)
BRIO 3B Dimension (mm): 730 x 430 (L x W)
BRIO 4B Dimension (mm): 675 x 520 (L x W)
BRIO PLUS 4B Dimension (mm): 960 x 400 (L x W)

WARRANTY * 5 Years on Burners & Valves, 2 Years Comprehensive

Auto Ignition Variants are also Available



MAJESTIC 3B Dimension (mm): 730 x 430 (L x W)
MAJESTIC 4B Dimension (mm): 950 x 370 (L x W)

WARRANTY * 5 Years on Burners & Valves, 2 Years Comprehensive

Auto Ignition Variants are also Available



WATCH NOW



CURVV
WITH PRECI FLAME BURNER



WATCH NOW



DUKE PLUS
WITH ULTRA SLIM BODY



CURVV 3B Dimension (mm): 770 x 380 (L x W)



CURVV 4B Dimension (mm): 730 x 500 (L x W)

WARRANTY * 5 Years on Burners & Valves, 2 Years Comprehensive



DUKE PLUS 3B Dimension (mm): 730 x 430 (L x W)



DUKE PLUS 4B Dimension (mm): 950 x 430 (L x W)

WARRANTY * 5 Years on Burners & Valves, 2 Years Comprehensive

Auto Ignition Variants are also Available

DEFENDER

WITH MATTE FINISH TOUGHENED GLASS

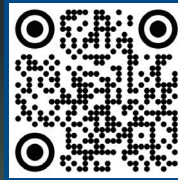

WATCH NOW



DEFENDER 4B

Dimension (mm): : 585 x 500 (L x W)

★ WARRANTY ★
 10 Years on Glass & Valves
 5 Years on Burners
 2 Years Comprehensive

Available in 3 Burner also

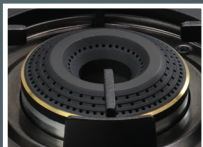

5G TECH BURNER
HIGH FUEL EFFICIENT
BRASS BURNER



BLACK METAL KNOB
SLEEK, STRONG, PRECISE



FLAME GUARD PAN SUPPORT
STABLE, SAFE, CHEF- GRADE



**LUXE SLEEK DESIGN,
MATTE FINISH
TOUGHENED GLASS**

STATE	LOCATION	SERVICE CENTER NAME
DELHI	EAST	SK ENTERPRISE
	SOUTH DELHI	THE KITCHEN HEART GALLERY
	NORTH DELHI	RK ENTERPRISES
	WEST DELHI	SHIV PRAKASH
	FARIDABAD	HEMANT KUMAR
	GURGAON	SANJAY KUMAR
	ROHTAK	RAVIKANT KUMAR
	SIRSA	SONU GAS REPAIRING
	SONIPAT	RAVI ENTERPRISES
	AMBALA/YAMUNA NAGAR	HAPPY HOME CARE
HARYANA	KARNAL/KURUSHETRA/KATHAL/PANIPAT	KAMALJEET
	REWARI	DINESH JI
	HISAR	RAJKARAN CO.
	JIND	AAKASH REFERGERTIONS
	MEERUT	RELIABLE WORK STATION
	AGRA	RANA ENTERPRISES
	MAINPURI/FIROZABAD/ETAWAH	RASHI ENTERPRISES
	BAREILLY	VISHAL ENTERPRISES
	MORADABAD	AMIT CHARAN
	SHAHJAHANPUR	VERMA JI TRADERS
UTTAR PRADESH	KANPUR	GEETA SERVICE
	ALIGARH	PDS HOME APPLIANCES
	FARUKHABAD	MULTICARE SERVICES
	SITAPUR	DEVSONS APPLIANCES
	LUCKNOW	ARYAN ENTERPRISES
	LUCKNOW	SAMAR TRADING SOLUTIONS
	ALLAHABAD/PARYAGRAJ	KRISHNA ENTERPRISES
	VARANASI	SAI SALES SERVICES
	KHIRI LAKHIMPUR	SHUBHAM KUMAR
	BULANDSAHAR	GAYATRI ENTERPRISES
MIRZAPUR	DEVANSH ELECTRONICS	
GORAKHPUR	VIKAS KUMAR	
SHAMLI	BALAJI ENTERPRISES	
SULTANPUR	MOHD JASEEM	
GHAZIABAD	ALBITONIC	
NOIDA	KK ENTERPRISES	
SAHARANPUR	QBEROI ENTERPRISE	
MUZZAFFARNAGAR	RUHALA ELECTRONICS	
BAHRAICH/GONDA	RUHANI APPLIANCES	
BUNORE	COOL POINT	
FAIZABAD/AYODHYA	DS ENTERPRISES	
LAKHIMPUR	SAMAR ENTERPRISES	
ORAI	SHIVHARE ENTERPRISE	
BASTI	DEVANAND	
HARDOI	SAMBHAVI ENTERPRISES	
AMETHI/RABAREILLY	HOME IN SERVICE	
MADHYA PRADESH	BHOPAL	DOLLY
	MANDSOOR	OM SHARMA
	SAGAR	HOME COMFORT
	NEEMUCH	SHANU PATIDAR
	JABALPUR/REWA	RAHUL
	INDORE	SHIVA KITCHEN APPLIANCES SALES & SERVICES
	RATLAM/UJJAIN	OVESH KHAN
	GWALIOR	ANKIT KUMAR
	AHMEDABAD	SHIVAAY SALES & SERVICE
	ALL GUJARAT	HS HOME APPLIANCES
MEHSANA	RIYA SERVICE CENTER	
RAJKOT	RADHE KRISHNA SERVICE CENTER	
SURAT	SHRI SAI KRUPA TRADING CO.	
JAIPUR	GLNIKA SERVICES	
JODHPUR	MK ENTERPRISES	
AJMER	SHREJI AGENCIES	
PALI	KHEDA KITCHENWARE	
BHILWARA	KAMAL ENTERPRISES	
UDAIPUR	MISHETA ENTERPRISES	
KOTA	SARTAJ	
SIKAR	BABU LAL	
BIKANER	SHRI RAJ ELECTRICALS	
NATHDWARA /RAJASMAND	SARTAJ	
GANGANAGAR	MUKHRAM VERMA	
AMRITSAR	KULDEEP SINGH	
BATALA/PATHANKOT/GURDASPUR	EKTA ELECTRIC CENTER	
BHATINDA	FRIENDS APPLIANCES CARE	
JALANDHAR	ACCURATE SERVICE	
MUKTSAR	CK APPLIANCES	
FIROZPUR/FARIDKOT	FINE TRADERS	
NAWASAHAR	ABHI ENTERPRISES	
LUDHIANA	KRISHNA TRADERS	
PATIALA	NEW SWAMI ELECTRICALS	
MOGA	SS TRADERS	
CHANDIGARH	SAI SALES CORPORATION	
GUJARAT		
RAJASTHAN		
PUNJAB		

